

# Yealink

## LCD Expansion Module EXP40

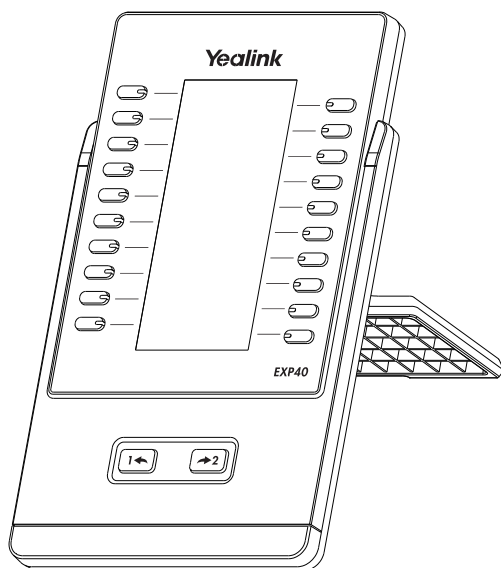

**Quick Start Guide (V16.3)**

## Packaging Contents

The following items are included in your package. If you find anything missing, contact your system administrator.

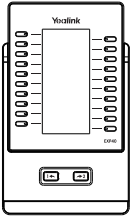

Expansion Module

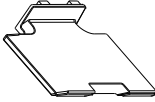

Stand

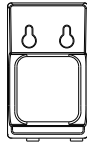

Wallmount  
Bracket  
(Optional)



Screw x4



Screwdriver

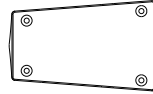

Connecting Sheet

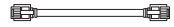

Connecting Cord

## Connecting to the Phone

1. Connect the EXP40 and the phone using the supplied screws and connecting sheet, as shown below:

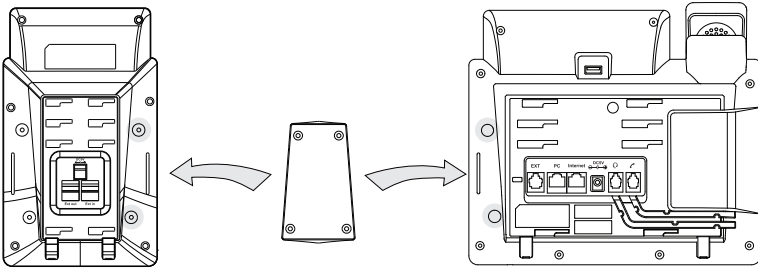

Your phone and the expansion module will be connected as shown below:

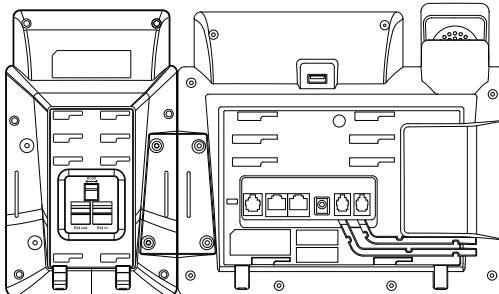

## Connecting two Modules

2. Follow the same step to connect two expansion modules:

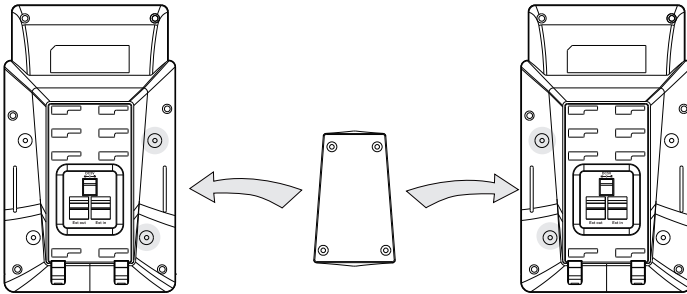

Your phone and the two expansion modules will be connected as shown below:

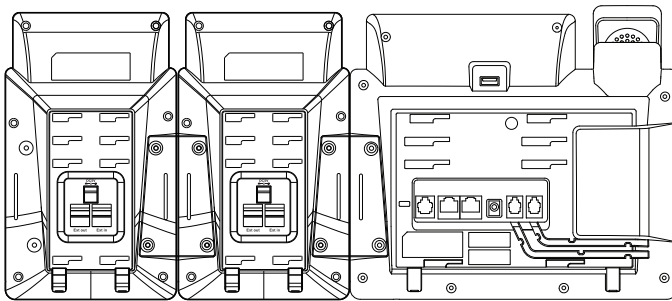

**Note:** The T48S/T48G/T46S/T46G IP phone can support six expansion modules at most. But if you use more than two expansion modules, you need to connect an additional power adapter to any one of the expansion modules.

## Connecting the Cords

3. Connect the Ext jack of the IP phone and the Ext in jack of the first module using a connecting cord. If you want to connect another module, connect the Ext out jack of the first module and the Ext in jack of the second module using a connecting cord.

As shown below:

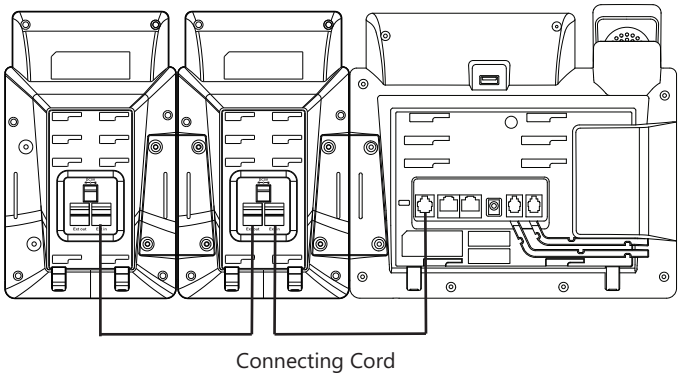

Note: You can connect six modules at most. You just need to connect the Ext in jack of the previous module and the Ext out jack of the next module using a connecting cord.



Then you can attach the stand, the power adapter and the Ethernet cable to the phone, connect the handset and headset to use.

## Assembling the EXP40

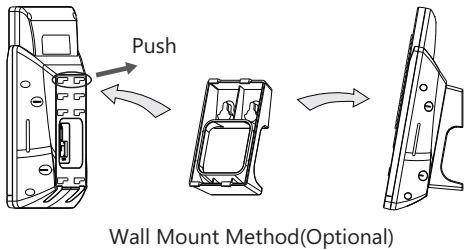
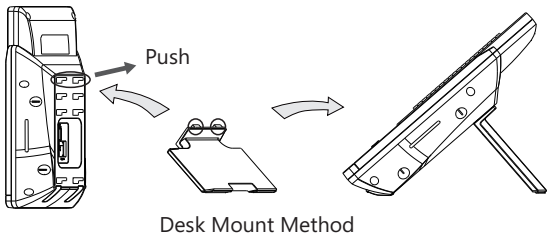
Attach the stand or the optional wall mount bracket, as shown below:



## Basic Configurations

The EXP40 supports 40 DSS keys in two screen page. Each page displays 20 DSS keys. You can press  or  to switch between the two pages and use your desired DSS key.

You can assign a feature to a DSS key via phone user interface. Press the desired DSS key of EXP40 for about 5 seconds, the phone LCD screen will prompt the setting of this key. The following sections provide you with detailed instruction of assigning some frequently used features to the DSS keys via web user interface.

### Conference

The conference key allows you to set up a conference with a third party when already in a call.

1. Click on **DSSKey->Ext Key**.
2. In the desired DSS key field, select **Conference** from the pull-down list of **Type**.
3. Enter the phone number or extension of the destination party in the **Value** field.
4. Enter the desired value in the **Label** field.
5. Click **Confirm** to accept the change.

### Forward

When there is an incoming call, you can press the forward key to forward the incoming call to the pre-defined destination number.

1. Click on **DSSKey->Ext Key**.
2. In the desired DSS key field, select **Forward** from the pull-down list of **Type**.
3. Enter the destination number you want to forward the incoming calls to in the **Value** field.
4. Enter the desired value in the **Label** field.
5. Click **Confirm** to accept the change.

### Transfer

You can press the transfer key to perform a Blind/ Semi-Attend/Attended transfer during a call.

1. Click on **DSSKey->Ext Key**.
2. In the desired DSS key field, select **Transfer** from the pull-down list of **Type**.
3. Enter the phone number you want to transfer the call to in the **Value** field.
4. Enter the desired value in the **Label** field.
5. Click **Confirm** to accept the change.

### Hold

You can press the hold key to hold and retrieve a call.

1. Click on **DSSKey->Ext Key**.
2. In the desired DSS key field, select **Hold** from the pull-down list of **Type**.
3. Enter the desired value in the **Label** field.
4. Click **Confirm** to accept the change.

### DND

You can press the DND key when the phone is idle to activate or deactivate the DND mode.

1. Click on **DSSKey->Ext Key**.
2. In the desired DSS key field, select **DND** from the pull-down list of **Type**.
3. Enter the desired value in the **Label** field.
4. Click **Confirm** to accept the change.

### ReCall

You can place a call back to the caller of the last incoming call by pressing the ReCall key.

1. Click on **DSSKey->Ext Key**.
2. In the desired DSS key field, select **ReCall** from the pull-down list of **Type**.
3. Enter the desired value in the **Label** field.
4. Click **Confirm** to accept the change.

---

## SMS

You can access the SMS more quickly and easily by pressing the SMS key.

1. Click on **DSSKey->Ext Key**.
2. In the desired DSS key field, select **SMS** from the pull-down list of **Type**.
3. Enter the desired value in the **Label** field.
4. Click **Confirm** to accept the change.

## Direct Pickup

If you press the directed pickup key when the specific phone number receives an incoming call, the call is answered on your phone.

1. Click on **DSSKey->Ext Key**.
2. In the desired DSS key field, select **Direct Pickup** from the pull-down list of **Type**.
3. Enter the direct call pickup code followed by the specific number you want to pick up call from in the **Value** field.
4. Enter the desired value in the **Label** field.
5. Select the desired line from the pull-down list of **Line**.
6. Click **Confirm** to accept the change.

## Group Pickup

You can pick up the incoming call of the pre-defined group by pressing the group pickup key.

1. Click on **DSSKey->Ext Key**.
2. In the desired DSS key field, select **Group Pickup** from the pull-down list of **Type**.
3. Enter the group call pickup code in the **Value** field.
4. Enter the desired value in the **Label** field.
5. Select the desired line from the pull-down list of **Line**.
6. Click **Confirm** to accept the change.

## Call Park

You can park a call at an extension by pressing the call park key. The current call is put on hold and can be retrieved on another IP phone.

1. Click on **DSSKey->Ext Key**.
2. In the desired DSS key field, select **Call Park** from the pull-down list of **Type**.
3. Enter the call park feature code in the **Value** field.
4. Enter the desired value in the **Label** field.
5. Select the desired line from the pull-down list of **Line**.
6. Click **Confirm** to accept the change.

## DTMF

You can send out the pre-defined DTMF sequence during a call by pressing the DTMF key.

1. Click on **DSSKey->Ext Key**.
2. In the desired DSS key field, select **DTMF** from the pull-down list of **Type**.
3. Enter the desired DTMF sequence in the **Value** field.
4. Enter the desired value in the **Label** field.
5. Click **Confirm** to accept the change.

## Voice Mail

You can access the voice mail more quickly by pressing the voice mail key.

1. Click on **DSSKey->Ext Key**.
2. In the desired DSS key field, select **Voice Mail** from the pull-down list of **Type**.
3. Enter the voice mail access code in the **Value** field.
4. Enter the desired value in the **Label** field.
5. Select the desired line from the pull-down list of **Line**.
6. Click **Confirm** to accept the change.

---

## Speed Dial

You can speed up dialing the numbers which are frequently used or hard to remember by pressing the speed dial key.

1. Click on **DSSKey->Ext Key**.
2. In the desired DSS key field, select **Speed Dial** from the pull-down list of **Type**.
3. Enter the desired number you want to dial out directly in the **Value** field.
4. Enter the desired value in the **Label** field.
5. Select the desired line from the pull-down list of **Line**.
6. Click **Confirm** to accept the change.

## Intercom

You can connect to the operator or the secretary more quickly by pressing the intercom key in an office environment .

1. Click on **DSSKey->Ext Key**.
2. In the desired DSS key field, select Intercom from the pull-down list of **Type**.
3. Enter the remote extension number in the **Value** field.
4. Enter the desired value in the **Label** field.
5. Select the desired line from the pull-down list of **Line**.
6. Click **Confirm** to accept the change.

## Line

You can configure a DSS key as the line key. It performs the same as a hard line key.

1. Click on **DSSKey->Ext Key**.
2. In the desired DSS key field, select **Line** from the pull-down list of **Type**.
3. Select the desired line from the pull-down list of **Line**.
4. Click **Confirm** to accept the change.

## BLF

The BLF key allows you to monitor the status of the pre-defined number. You can also pick up incoming calls of the monitored number.

1. Click on **DSSKey->Ext Key**.
2. In the desired DSS key field, select **BLF** from the pull-down list of **Type**.
3. Enter the phone number or extension you want to monitor in the **Value** field.
4. Enter the desired value in the **Label** field.
5. Select the desired line from the pull-down list of **Line**.
6. Enter the directed call pickup code in the **Extension** field.
7. Click **Confirm** to accept the change.

## Group Listening

You can configure a DSS key as the group listening key. Then you are allowed to activate the Speakerphone mode and Handset/Headset mode at the same time by pressing the group listening key.

1. Click on **DSSKey->Ext Key**.
2. In the desired DSS key field, select **Group Listening** from the pull-down list of **Type**.
3. Enter the desired value in the **Label** field.
4. Click **Confirm** to accept the change.

## LDAP

LDAP is an application protocol for accessing and maintaining information services of the distributed directory over an IP network. The IP phone can be configured to interface with a corporate directory server that supports LDAP. You can configure a DSS key as the LDAP key. If you press the LDAP key, the IP phone will download and display the LDAP entries on the LCD screen.

1. Click on **DSSKey->Ext Key**.
2. In the desired DSS key field, select **LDAP** from the pull-down list of **Type**.
3. Enter the desired value in the **Label** field.
4. Click **Confirm** to accept the change.

## **About us**

Founded in 2001, Yealink, a leading provider of VoIP Phone and IP communication solutions, has been focusing on VoIP products characterized by reliable quality, easy deployment and affordable price for more than a decade. Today, customers from over 140 countries rely on Yealink as the backbone of global collaboration to extend the value of network communications.

## **More about Yealink**

Since 2001, Yealink has continued to develop state-of-the art, hi-tech VoIP communication terminals that include IP video phones, IP phones and USB phones. With a worldwide market in more than 140 countries, the company has also established a first-class international service network.

Our priorities are quality, functionality, ease-of-use, customer support and competitive pricing. To provide new solutions for the future in this fast-evolving sector, Yealink's large, talented and highly-experienced VoIP R&D team is totally committed to the pursuit of excellence.

To date, we have passed more than 80 interoperability tests and meet certification requirements set by leading VoIP system and platforms. Yealink works in close partnership with T-Mobile, Telefonica, Portugal Telecom and other leading telecommunication service providers.



YEALINK(XIAMEN) NETWORK TECHNOLOGY CO.,LTD.  
Web: [www.yealink.com](http://www.yealink.com)  
Addr: 309, 3th Floor, No.16, Yun Ding North Road, Huli  
District, Xiamen City, Fujian, P.R. China  
Copyright©2016Yealink Inc.All right reserved.